

DATABLAD:

BEND 30°

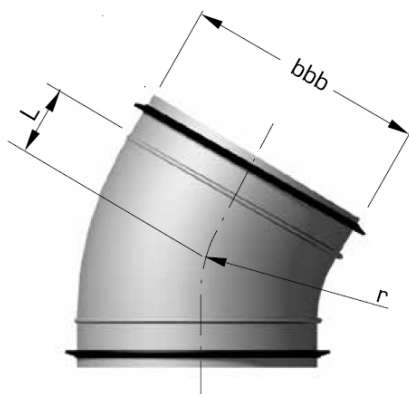

bbb mm	L mm	r mm	Vekt kg
100	25	100	0,24
125	30	125	0,28
160	40	160	0,40