

DATABLAD:

BEND 45°

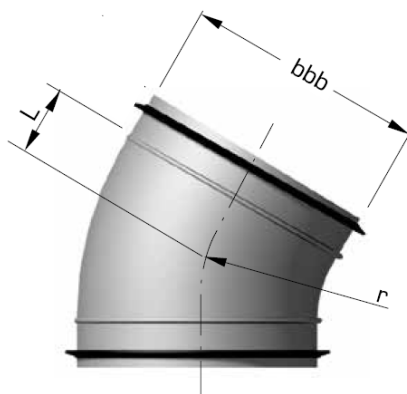

bbb mm	L mm	r mm	Vekt kg
100	40	100	0,20
125	50	125	0,28
160	65	160	0,42